

PolarHT™ HiPerFET IXFC 96N15P

Power MOSFET

ISOPLUS220™

(Electrically Isolated Back Surface)

N-Channel Enhancement Mode
Fast Recovery Diode, Avalanche Rated

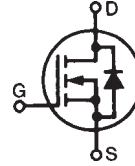

$$V_{DSS} = 150 \text{ V}$$

$$I_{D25} = 42 \text{ A}$$

$$R_{DS(on)} = 26 \text{ m}\Omega$$

$$t_{rr} < 200 \text{ ns}$$

ISOPLUS 220™
E153432

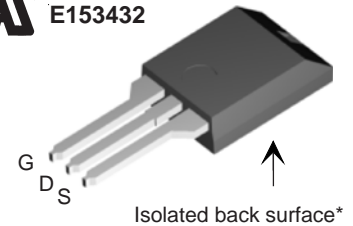

G = Gate
S = Source
D = Drain

Symbol	Test Conditions	Maximum Ratings	
V_{DSS}	$T_J = 25^\circ\text{C}$ to 175°C	150	V
V_{DGR}	$T_J = 25^\circ\text{C}$ to 175°C ; $R_{GS} = 1 \text{ M}\Omega$	150	V
V_{GS}	Continuous	± 20	V
V_{GSM}	Transient	± 30	V
I_{D25}	$T_C = 25^\circ\text{C}$	42	A
I_{DM}	$T_C = 25^\circ\text{C}$, pulse width limited by T_{JM}	250	A
I_{AR}	$T_C = 25^\circ\text{C}$	60	A
E_{AR}	$T_C = 25^\circ\text{C}$	40	mJ
E_{AS}	$T_C = 25^\circ\text{C}$	1.0	J
dv/dt	$I_S \leq I_{DM}$, $di/dt \leq 100 \text{ A}/\mu\text{s}$, $V_{DD} \leq V_{DSS}$, $T_J \leq 175^\circ\text{C}$, $R_G = 4 \Omega$	10	V/ns
P_D	$T_C = 25^\circ\text{C}$	120	W
T_J		-55 ... +175	$^\circ\text{C}$
T_{JM}		175	$^\circ\text{C}$
T_{stg}		-55 ... +150	$^\circ\text{C}$
T_L	1.6 mm (0.062 in.) from case for 10 s	300	$^\circ\text{C}$
F_C	Mounting force	11...65/2.4...11	N/lb
V_{ISOL}	50/60 Hz, 1 minute	2500	~V
Weight		3	g

Features

- Silicon chip on Direct-Copper-Bond substrate
- High power dissipation
- Isolated mounting surface
- 2500V electrical isolation
- Low drain to tab capacitance (<35pF)
- Low $R_{DS(on)}$ HDMOS™ process
- Rugged polysilicon gate cell structure
- Unclamped Inductive Switching (UIS) rated
- Fast intrinsic Rectifier

Applications

- DC-DC converters
- Battery chargers
- Switched-mode and resonant-mode power supplies
- DC choppers
- AC motor control

Advantages

- Easy assembly: no screws, or isolation foils required
- Space savings
- High power density
- Low collector capacitance to ground (low EMI)

Symbol	Test Conditions	Characteristic Values		
		Min.	Typ.	Max.
BV_{DSS}	$V_{GS} = 0 \text{ V}$, $I_D = 250 \mu\text{A}$	150		V
$V_{GS(th)}$	$V_{DS} = V_{GS}$, $I_D = 4 \text{ mA}$	3.0		5.0 V
I_{GSS}	$V_{GS} = \pm 20 V_{DC}$, $V_{DS} = 0$			$\pm 100 \text{ nA}$
I_{DSS}	$V_{DS} = V_{DSS}$, $V_{GS} = 0 \text{ V}$			25 μA 300 μA
$R_{DS(on)}$	$V_{GS} = 10 \text{ V}$, $I_D = 48 \text{ A}$, Note 1 Pulse test, $t \leq 300 \mu\text{s}$, duty cycle $d \leq 2 \%$			26 $\text{m}\Omega$

Symbol	Test Conditions	Characteristic Values ($T_J = 25^\circ\text{C}$, unless otherwise specified)		
		Min.	Typ.	Max.
g_{fs}	$V_{DS} = 10\text{ V}$; $I_D = 48\text{ A}$, Note 1	35	45	S
C_{iss}	$V_{GS} = 0\text{ V}$, $V_{DS} = 25\text{ V}$, $f = 1\text{ MHz}$		3500	pF
C_{oss}			1000	pF
C_{rss}			280	pF
$t_{d(on)}$	$V_{GS} = 10\text{ V}$, $V_{DS} = 0.5 V_{DSS}$, $I_D = 48\text{ A}$ $R_G = 4\ \Omega$ (External)		30	ns
t_r			33	ns
$t_{d(off)}$			66	ns
t_f			18	ns
$Q_{g(on)}$	$V_{GS} = 10\text{ V}$, $V_{DS} = 0.5 V_{DSS}$, $I_D = 48\text{ A}$		110	nC
Q_{gs}			26	nC
Q_{gd}			59	nC
R_{thJC}	(TO-247, PLUS220)			1.25 K/W
R_{thCS}		0.21		K/W

Symbol	Test Conditions	Characteristic Values ($T_J = 25^\circ\text{C}$, unless otherwise specified)		
		Min.	Typ.	Max.
I_S	$V_{GS} = 0\text{ V}$			96 A
I_{SM}	Repetitive			250 A
V_{SD}	$I_F = I_S$, $V_{GS} = 0\text{ V}$,			1.5 V
t_{rr}	$I_F = 25\text{ A}$ $-di/dt = 100\text{ A}/\mu\text{s}$ $V_R = 100\text{ V}$, $V_{GS} = 0\text{ V}$			200 ns
Q_{RM}			600	nC
I_{RM}			6	A

Notes: 1. Pulse test, $t \leq 300\ \mu\text{s}$, duty cycle $d \leq 2\%$

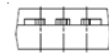
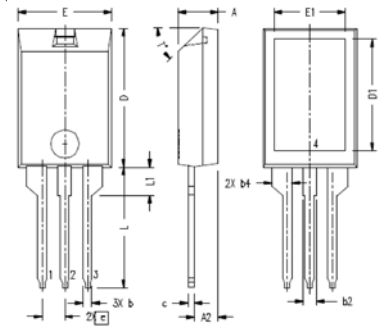
ISOPLUS220™ (IXFC) Outline

Note:
Bottom heatsink (Pin 4) is electrically isolated from Pin 1, 2, or 3.

SYM	INCHES		MILLIMETERS	
	MIN	MAX	MIN	MAX
A	.157	.197	4.00	5.00
A2	.098	.118	2.50	3.00
b	.035	.051	0.90	1.30
b2	.049	.065	1.25	1.65
b4	.093	.100	2.35	2.55
c	.028	.039	0.70	1.00
D	.591	.630	15.00	16.00
D1	.472	.512	12.00	13.00
E	.394	.433	10.00	11.00
E1	.295	.335	7.50	8.50
e	.100 BASIC		2.55 BASIC	
L	.512	.571	13.00	14.50
L1	.118	.138	3.00	3.50
T*			42.5*	47.5*

Ref: IXYS CO 0177 R0

IXYS reserves the right to change limits, test conditions, and dimensions.

IXYS MOSFETs and IGBTs are covered by one or more of the following U.S. patents:

4,835,592	4,931,844	5,049,961	5,237,481	6,162,665	6,404,065 B1	6,683,344	6,727,585
4,850,072	5,017,508	5,063,307	5,381,025	6,259,123 B1	6,534,343	6,710,405 B2	6,759,692
4,881,106	5,034,796	5,187,117	5,486,715	6,306,728 B1	6,583,505	6,710,463	6,771,478 B2

**Fig. 1. Output Characteristics
@ 25°C**

**Fig. 2. Extended Output Characteristics
@ 25°C**

**Fig. 3. Output Characteristics
@ 150°C**

**Fig. 4. $R_{DS(on)}$ Normalized to $I_D = 48$ A
Value vs. Junction Temperature**

**Fig. 5. $R_{DS(on)}$ Normalized to
 $I_D = 48$ A Value vs. I_D**

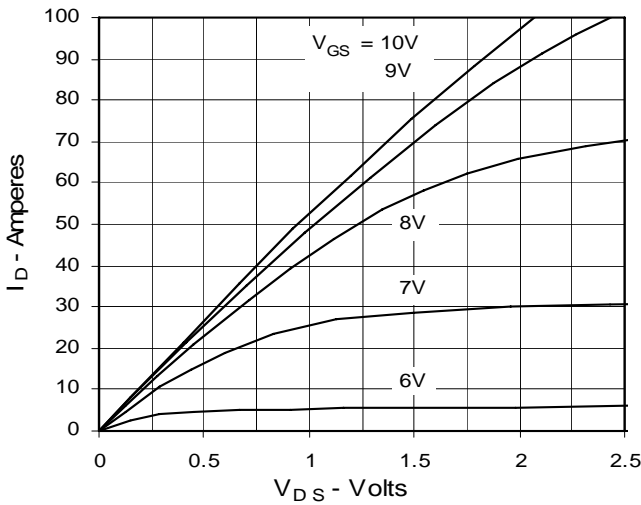
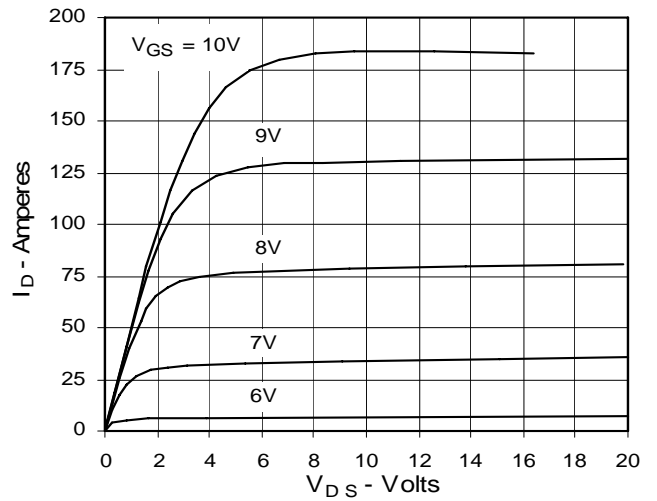
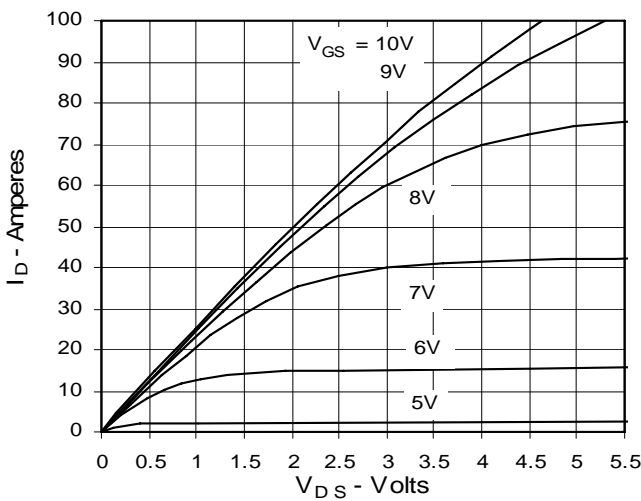
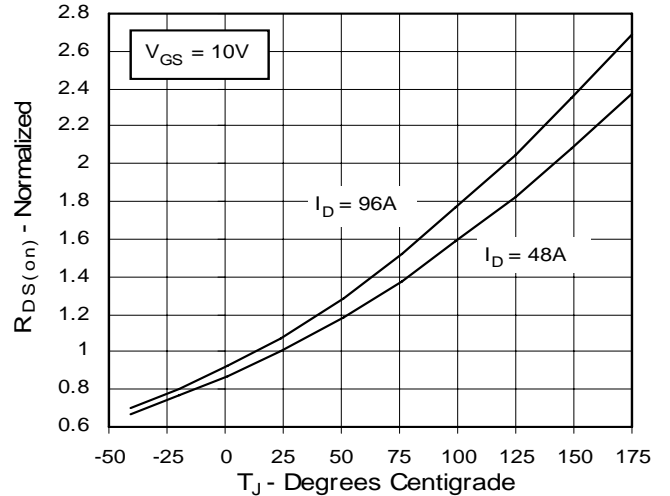
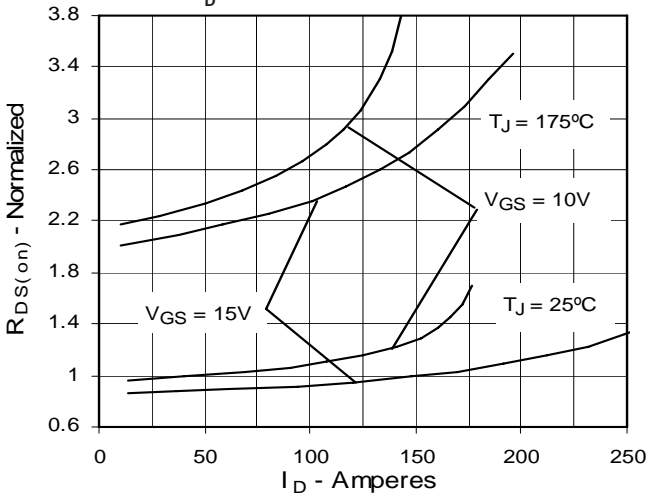
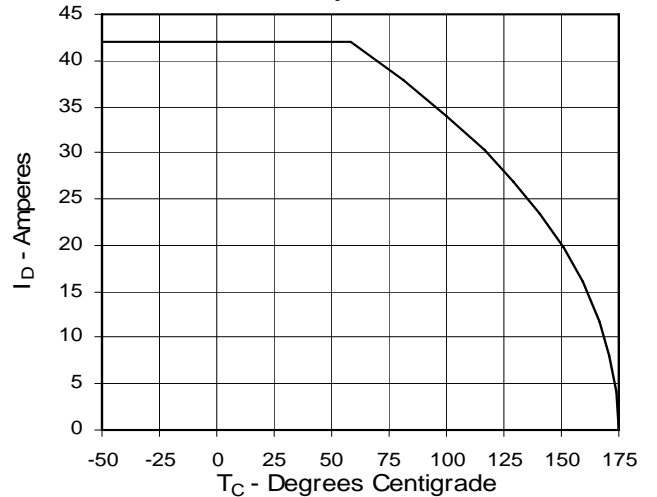
**Fig. 6. Drain Current vs. Case
Temperature**

Fig. 7. Input Admittance

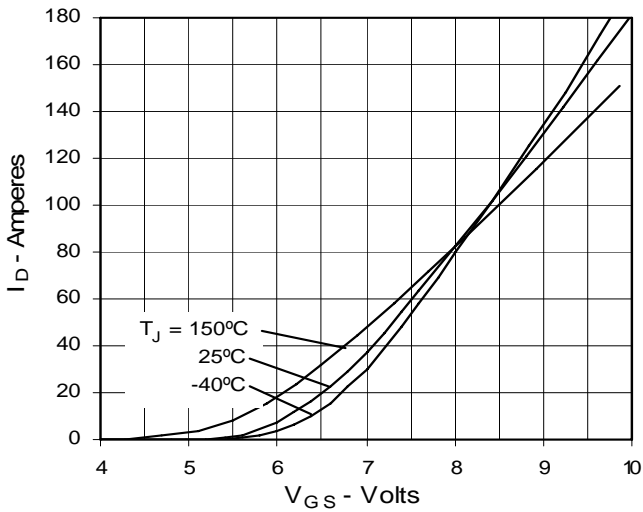

Fig. 8. Transconductance

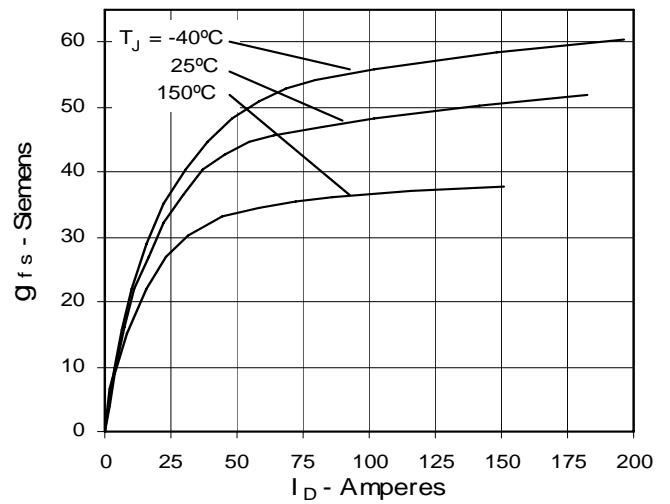

Fig. 9. Source Current vs. Source-To-Drain Voltage

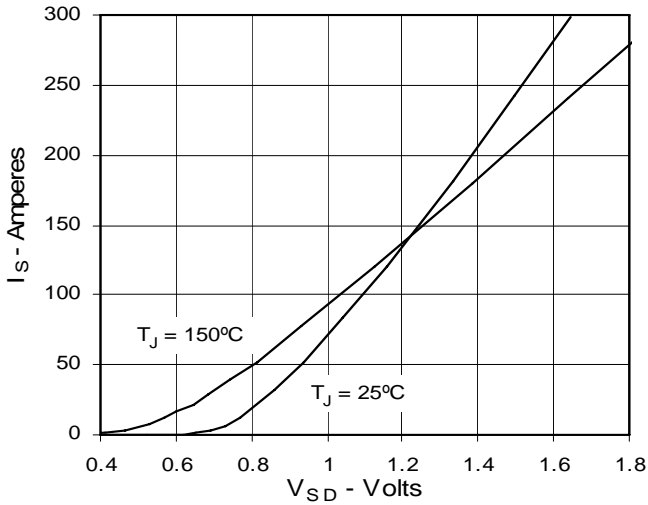

Fig. 10. Gate Charge

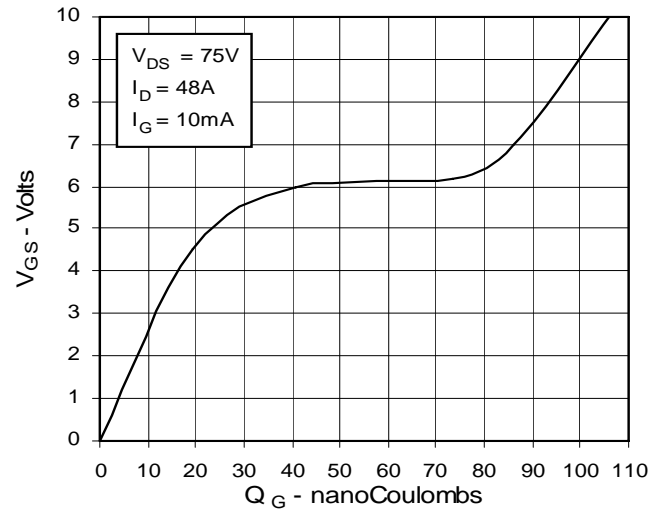

Fig. 11. Capacitance

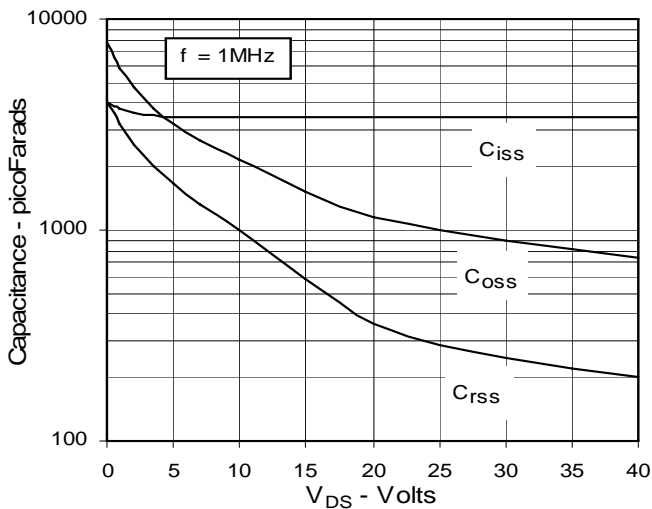

Fig. 12. Forward-Bias Safe Operating Area

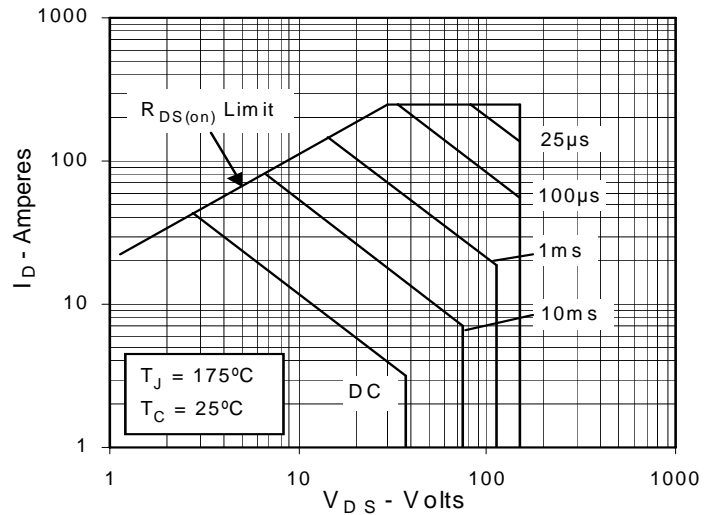

Fig. 13. Maximum Transient Thermal Resistance

